

Time-resolved Bell Correlation Spectroscopy of Molecular Vibrations

Santiago Tarrago Velez,¹ Vivishek Sudhir,^{2,3} Nicolas Sangouard,^{4,5} and Christophe Galland¹

¹*Institute of Physics, Ecole Polytechnique Fédérale de Lausanne, CH-1015 Lausanne, Switzerland*

²*LIGO Laboratory, Massachusetts Institute of Technology, Cambridge, MA 02139, USA*

³*Department of Mechanical Engineering, Massachusetts Institute of Technology, Cambridge, MA 02139, USA*

⁴*Departement Physik, Universität Basel, Klingelbergstrasse 82, CH-4056 Basel, Switzerland*

⁵*Institut de Physique Thorique, CEA & CNRS, Universit Paris-Saclay, France*

(Dated: December 11, 2019)

Quantum states of bulk oscillators can be important resources for quantum technologies. The development of versatile techniques to prepare and measure such states can in turn shed new light on the processes and time scales of decoherence in vibrational excitations. Here, we present a new scheme leveraging universal properties of Raman scattering to create quantum correlations between light and vibration that are strong enough to violate a Bell inequality. We measure the decay of these hybrid photon-phonon Bell correlations with sub-picosecond time-resolution and observe the decoherence of a vibrational qubit encoded in two time bins. The experiment relies on a molecular vibrational mode featuring a record number of ~ 1000 quantum coherent oscillations at ambient conditions, which scatters light inelastically and can therefore be addressed by time-resolved single photon Raman spectroscopy. It paves the way for the study of quantum correlations in highly complex solid-state and molecular systems in their natural state, i.e. without any engineering of their coherence properties or interaction mechanisms.

I. INTRODUCTION

In the hierarchy of non-classical states, the Bell correlated states represent an extreme. Given such a state shared between two parties, information is exclusively encoded in the quantum correlations of their joint state, with none available to each independently [1, 2]. The violation of a Bell inequality demarcates the subset of such states from the general class of entangled states, and quantifies the strength of the quantum correlations existing between the two sub-systems.

First demonstrated with polarization-entangled photons [3, 4] as a crucial test of local causality [5, 6], Bell correlations have since been engineered between material systems, including individual atoms and ions, atomic ensembles, superconducting circuits, and solid-state electronic spins (see [7, 8] for recent reviews). These experiments require material systems that are highly decoupled from their environment while strongly interacting with a well-characterised probe. In this context, even mesoscopic acoustic resonators – engineered for long coherence times (which required operation at milli-Kelvin temperatures), and strongly interacting with light (by integration with an optical micro-cavity) – have been made to exhibit Bell correlations [9].

Intriguingly, recent experiments have shown that high-frequency internal vibrations in bulk crystals [10–14] or molecular ensembles [15–17] can mediate non-classical intensity correlations between inelastically scattered photons under ambient conditions (i.e. at room temperature and atmospheric pressure), with applications to ultra-broadband quantum memories [18–23] and ultra-fast quantum information processing [24–26]. In the pioneering work of Lee et al. [10], path entanglement of Raman-scattered photons originating from spatially separated bulk diamonds was demonstrated. However, the

observed correlations were not strong enough to violate a Bell inequality, nor was the technique applicable as a spectroscopic tool capable of resolving the temporal dynamics of the underlying quantum state.

Using a recently developed two-color pump-probe method [14] inspired from cavity optomechanics [27, 28], we have recently succeeded in resolving the birth and death of an individual vibrational quantum (i.e. Fock state) in a single spatio-temporal vibrational mode of a bulk crystal [29]. Remarkably, these experiments did not necessitate specially engineered subjects; they reveal fundamental quantum properties of naturally occurring materials.

Taken together, these recent developments raise the question: Can Bell correlations be observed between light and vibration at ambient conditions? Answering this question will improve our understanding of decoherence in collective molecular oscillators and will clarify their potential use in robust room-temperature quantum technologies [18–26].

Moreover, the ability to resolve the decoherence dynamics of Bell correlations – i.e. Bell correlation spectroscopy – would pave the way for translating concepts from device-independent quantum information processing [30, 31] to the realm of molecular spectroscopy. This will open the possibility to draw physics-based conclusions on the quantum correlations sustained in a system without requiring a detailed knowledge of the light-matter interaction and the system’s dynamics [32]. Ultimately, it may vastly increase the palette of materials available for quantum science and technology, based on a technique that is largely agnostic to material properties.

In this Letter, we present Bell correlation spectroscopy, a technique which is able to answer these questions for a potentially much larger class of Raman-active vibrations. We observe, for the first time, Bell correlations

between light and mechanical vibration at ambient conditions. We also perform the first time-resolved measurement of the decoherence of a vibrational qubit, which is encoded in two non-overlapping temporal modes. While this proof-of-principle experiment is realized on a vibrational mode in a bulk crystal of diamond as in [10], the effect that is revealed should be universally observable in Raman-active molecules [15–17] and solids [11]. Indeed, our scheme for the time-bin encoding of the vibrational qubit is agnostic to the sample details and is passively phase-stabilized, while our two-color pump-probe technique can address Raman-active vibrations independently of their polarisation selection rules – all of which markedly differ from Ref. [10] which relied on maintaining interferometric stability and required two identical samples with a strongly polarized Raman response. Our results demonstrate that the strongest and most spectacular form of quantum correlation is not limited to carefully isolated atomic systems or artificially engineered solid-state systems, but that they can be ubiquitously observed in nature when light inelastically scatters from a material.

II. DESCRIPTION OF THE SCHEME

Vibrational Raman scattering occurs when an internal vibrational mode of a material changes its optical polarizability, causing inelastic scattering of light [33]. This interaction between light and a vibrational mode is precisely analogous to the radiation-pressure interaction between light and a mechanically compliant mirror [34]. Specifically, the Raman interaction consists of two processes. In the Stokes process, a quantum of vibrational energy $\hbar\Omega_v$ (a phonon) is created together with a quantum of electromagnetic energy $\hbar\omega_s$ (a Stokes photon); while in the anti-Stokes process a phonon is annihilated while an anti-Stokes photon is created at angular frequency ω_a . Energy conservation demands that $\omega_{s,a} \pm \Omega_v = \omega_{\text{in}}$, for either process respectively, where ω_{in} is the angular frequency of the incoming photon.

In our experiment, a diamond sample is excited with femtosecond pulses from a mode-locked laser. The pulses are shorter than the coherence time of the Raman-active internal vibrational mode of diamond (optical phonon branch), but longer than its oscillation period. Under these conditions, there exists perfect classical time correlations between the generation (resp. annihilation) of a vibrational excitation and the inelastic scattering of a Stokes (resp. anti-Stokes) photon. In the following, we show how to leverage this classical time correlation to generate time-bin entanglement [35] between effective photonic and vibrational qubits and quantify the strength of the quantum correlations using the CHSH form [3] of the Bell inequality.

The scheme starts with a pair of laser pulses labeled “write” and “read”, each a classical wavepacket with a large photon number ($\sim 10^8 - 10^9$ per pulse). Im-

portantly, the central frequency of each pulse is tunable independently from the other, which allows us to spectrally filter the Stokes field generated by the write pulse and the anti-Stokes field generated by the read pulse and send them to separate detection apparatuses. The delay between them, Δt (Fig. 1), is adjustable (it will be used to probe the decoherence of the vibrational qubit). Each pulse passes through an unbalanced Mach-Zehnder interferometer, emerging at the output split into two pulses, one each in a temporal mode separated by $\Delta T_{\text{bin}} \gg \Delta t$, which we label the “early” and “late” time bins. $\Delta T_{\text{bin}} \simeq 3$ ns is chosen to be much longer than the expected vibrational coherence time, which ensures that there can be no quantum-coherent interaction between the two time bins mediated by the vibrational mode.

The vibrational mode (at 39.9 THz) effectively exists in its ground state at room temperature (thermal occupancy of 1.5×10^{-3}). The initial state of the vibration in the two time bins is therefore very well approximated by the ground state $|0_v\rangle \equiv |0_{v,E}\rangle \otimes |0_{v,L}\rangle$, where the subscripts E and L stand for the early and late time bins, respectively. The Stokes and anti-Stokes fields are also in the vacuum state at the start of the experiment, denoted by $|0_s\rangle \equiv |0_{s,E}\rangle \otimes |0_{s,L}\rangle$ and $|0_a\rangle \equiv |0_{a,E}\rangle \otimes |0_{a,L}\rangle$, respectively.

The write pulse, split into the two time bins, interact with the vibration, to generate a two-mode squeezed state of the Stokes and vibrational fields [29] (in each time bin). Subsequently, a read pulse, also split between the two time bins, maps the vibrational state (in the respective time bins, each delayed by Δt with respect to the write sequence) onto its anti-Stokes sideband.

Since we perform the experiment in the regime of very low Stokes scattering probability and post-select the outcomes where exactly one Stokes photon and one anti-Stokes photon were detected, our scheme can be described in a sub-space of the full Hilbert space that contains one vibrational excitation only, shared by the early and late time bin. We therefore introduce the shortened notation $|E_v\rangle \equiv \hat{v}_E^\dagger|0_v\rangle$; $|L_v\rangle \equiv \hat{v}_L^\dagger|0_v\rangle$ for the single phonon states (here \hat{v}^\dagger is the phonon creation operator), and $|E_s\rangle \equiv \hat{s}_E^\dagger|0_s\rangle$; $|L_s\rangle \equiv \hat{s}_L^\dagger|0_s\rangle$ for the Stokes single photon states (here \hat{s}^\dagger is the Stokes photon creation operator), in the two time bins. Conditioned on the detection of a single Stokes photon, the hybrid light–vibrational state can be written in the basis $\{|E_s\rangle, |L_s\rangle\} \otimes \{|E_v\rangle, |L_v\rangle\} = \{|E_s\rangle \otimes |E_v\rangle, |E_s\rangle \otimes |L_v\rangle, |L_s\rangle \otimes |E_v\rangle, |L_s\rangle \otimes |L_v\rangle\}$. In this sense, we can speak of vibrational and photonic qubits, in analogy with any other two-level system that can be prepared in a quantum superposition.

Within each time bin, the read pulse implements (with a small probability $\sim 0.1\%$) the map $|E_s, E_v\rangle \rightarrow |E_s, E_a\rangle$ and $|L_s, L_v\rangle \rightarrow |L_s, L_a\rangle$, where we have defined $|E_a\rangle \equiv \hat{a}_E^\dagger|0_a\rangle$ and $|L_a\rangle \equiv \hat{a}_L^\dagger|0_a\rangle$ (here $\hat{a}_{E,L}^\dagger$ are the creation operators for the anti-Stokes photon in each time bin). Detection of an anti-Stokes photon in coincidence with a Stokes photon from the write pulse heralds that the time

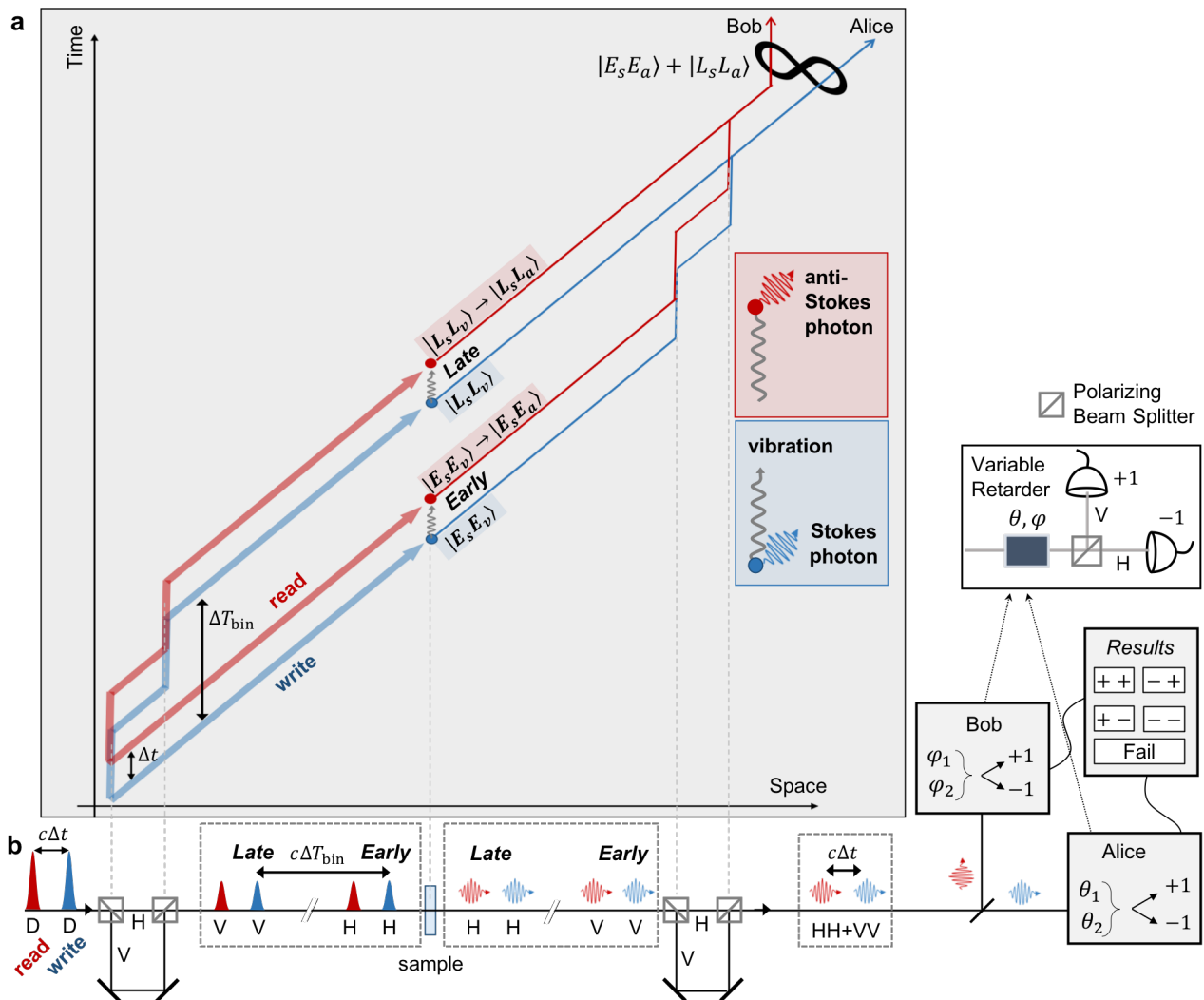

FIG. 1. **Conceptual scheme and simplified experimental layout.** **a**, Space-time diagram representation of the time-bin entanglement procedure. **b**, Corresponding experimental implementation unfolded in space along the horizontal axis (see SI for a detailed experimental layout). Contents of the dashed boxes illustrate the time sequence and polarization of the excitation pulses (Gaussian pulses) and Raman-scattered photons (wavy arrows), during a single repetition of the experiment. The polarization states are denoted by D (diagonal), H (horizontal) and V (vertical). The vertical dashed lines in panel **a** correspond to different points in space along the setup.

bin qubit was successfully mapped onto an anti-Stokes photonic qubit.

By passing the Raman scattered photons (Stokes and anti-Stokes) through an identical unbalanced interferometer as the one used to define the two time bins (Fig. 1b), “which-time” information is erased, so that we prepare the Bell correlated state,

$$|\psi_{s,a}\rangle = \frac{1}{\sqrt{2}} (|E_s, E_a\rangle + e^{i\phi_0} |L_s, L_a\rangle) \quad (1)$$

where the phase ϕ_0 is the sum of the phases acquired by the Stokes and anti-Stokes photons coming from the late time bin, with respect to the early time bin. In the experiment, we pass the photons back through the same interferometer to erase the “which-time” informa-

tion. Consequently, by design, the experiment is passively phase-stabilized over the relevant time scale. Note that the apparatus is set to realize $\phi_0 = \pi$ (see SI).

In order to prove Bell correlations mediated by the room-temperature macroscopic vibration, we send the Stokes and anti-Stokes signals to two independent measurement apparatus labeled Alice and Bob, respectively. Through the use of polarizing beam splitters in the interferometer, the time-bin-encoded Stokes and anti-Stokes photonic qubits are mapped onto polarization-encoded qubits after they are temporally overlapped. In this way, after the Stokes and anti-Stokes fields are spectrally separated on an interference filter, their time-bin states can be rotated by Alice and Bob in their local bases using polarization analyzers followed by single-photon

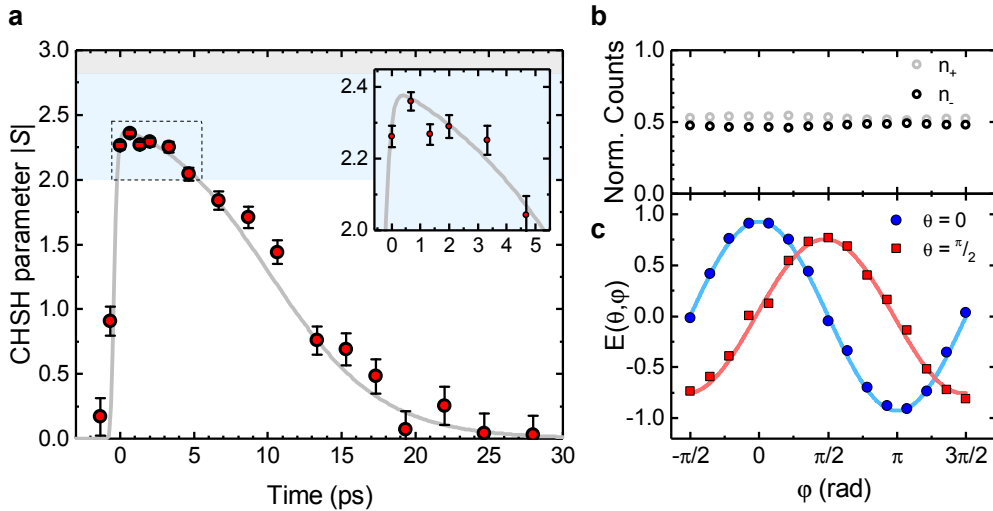

FIG. 2. **Photon-phonon Bell correlations and decoherence of the vibrational qubit.** **a**, The CHSH parameter S (eq. (3)) as a function of write – read delay Δt , with a zoom near $\Delta t = 0$ as an inset. Full circles are experimental data, while error bars are computed from a Monte Carlo simulation (see SI for details). The solid gray line is obtained from the model with zero pure dephasing and no other free parameters (see SI). The blue region, demarcated by $2 < |S| \leq 2\sqrt{2}$, certifies Bell correlations, while the gray region above it is forbidden for non-superluminal theories. **b**, Normalized single-photon count rates on the two anti-Stokes detectors as a function of Bob’s rotation angle φ . The ideal marginal state is the statistical mixture $p|E_a\rangle\langle E_a| - (1-p)|L_a\rangle\langle L_a|$, with $p = \frac{1}{2}$; data is consistent with $|p - \frac{1}{2}| = 0.027$. **c**, Two-photon interferences in the Stokes – anti-Stokes coincidence rate as a function of Bob’s rotation angle φ . The normalized correlation parameter $E(\theta, \varphi)$ (eq. 2) is plotted for two fixed angles $\theta = 0$ (blue circles) and $\theta = \pi/2$ (red squares) for Alice’s rotation on the Stokes state. Experimental data are represented by full symbols, solid lines are fitting curves (see SI for details). (Data in panels b and c are acquired at a fixed write – read delay of $\Delta t = 0.66$ ps.)

avalanche photodetector (operated in Geiger mode, with a 50% detection efficiency, and 500 ps timing jitter that is small enough to exclude extraneous events corresponding to distinguishable photons). Thus, effectively, Alice and Bob perform local rotations of the Stokes and anti-Stokes time-bin states independently before making a projective measurement in the fixed two-dimensional basis $\{|E_s\rangle, |L_s\rangle\}$ for Alice and $\{|E_a\rangle, |L_a\rangle\}$ for Bob (see SI for experimental implementation). Each party will obtain two possible outcomes, which we label “+” or “−”. The number of coincident events where Alice obtains the outcome $x \in \{+, -\}$ and Bob obtains the outcome $y \in \{+, -\}$ is denoted n_{xy} . From these four quantities, we compute the normalized correlation parameter,

$$E_{\theta, \varphi} = \frac{n_{++} + n_{--} - n_{+-} - n_{-+}}{n_{++} + n_{--} + n_{+-} + n_{-+}} \quad (2)$$

where the angles θ and φ label the rotations that Alice and Bob respectively perform on their qubits before the measurement. This parameter is defined in such a way that fully correlated events for a given pair of rotation angles $\{\theta, \varphi\}$ yield $E_{\theta, \varphi} = 1$ while perfectly anti-correlated events yield $E_{\theta, \varphi} = -1$. We then evaluate the CHSH parameter [2],

$$S = E_{\theta_1, \varphi_1} + E_{\theta_2, \varphi_2} + E_{\theta_1, \varphi_2} - E_{\theta_2, \varphi_1} \quad (3)$$

which certifies Bell correlations when $|S| > 2$. In particular, for our scenario, where we target the Bell cor-

related state $|\phi_-\rangle = \frac{1}{\sqrt{2}}(|E_s, E_a\rangle - |L_s, L_a\rangle)$, a maximal violation is expected for $\{\theta_1, \theta_2\} = \{0, \frac{\pi}{2}\}$ and $\{\varphi_1, \varphi_2\} = \{-\frac{\pi}{4}, \frac{\pi}{4}\}$.

III. RESULTS

Figure 2a shows the CHSH parameter (eq. (3)) measured for a varying write-read delay under the different choices of rotation angles by Alice and Bob. Our data demonstrates a clear violation of the Bell inequality (whose classical bound is marked as the white region) which persists for more than 5 ps (consistent with the characteristic time scale of single phonon decoherence in diamond [29]), and about 50 times longer than the write and read pulse duration. In fact, at a time delay of 0.66 ps, when any artifact that could arise due to the temporal overlap of the write and read pulses within the sample can be excluded, we measure $S = 2.360 \pm 0.025$. This confirms that our measurement characterizes Bell correlations mediated by the vibration that acts as a room-temperature quantum memory.

A detailed analysis (see SI) of the event statistics enables us to make a more precise claim concerning the violation of the Bell inequality [36]. With 99.99994% confidence (corresponding to the case where the true value of S being smaller than S_{\min} would correspond to a 5σ

deviation from the peak of the probability distribution) we can give a lower bound for the CHSH parameter of $S_{\min} = 2.23$. We are thus able to reject the hypothesis that our data are produced by a non-Bell correlated state with a confidence level of 99.99994%.

To gain further insight into the precise Bell correlated state prepared in our experiment, we perform further checks. Figure 2b shows the one-photon counts as Bob's analysis angle is rotated. For an ideal Bell state, the marginal is maximally mixed, and should lead to no dependence of the one-photon counts on the analysis angle. The observed data is consistent with a deviation from a maximal mixture by 2.7%.

Figure 2c shows two-photon interference for various settings of Bob's measurement angle (for two fixed values of Alice's measurement angle, $\theta = 0$, $\pi/2$, and a fixed write-read delay of 0.66 ps). The curve for the setting $\theta = 0$ (fig. 2c blue trace) reveals how accurately we can prepare and distinguish the two states $|E_s, E_a\rangle$ versus $|L_s, L_a\rangle$. At a given delay, the visibility has an upper limit related to the strength of Stokes – anti-Stokes photon number correlations, $V_{\max} = \frac{g_{s,a}^{(2)} - 1}{g_{s,a}^{(2)} + 1}$ [37], where $g_{s,a}^{(2)}$ is the normalized second-order cross-correlation [14] (see SI for details). The value extracted from the fit is $V_{\theta=0} = 93 \pm 1\%$, while we measure $g_{s,a}^{(2)}(0) = 25$, showing that the signal-to-noise ratio in the cross-correlation is the limiting factor for the visibility in this setting.

On the other hand, the coincidence curve for $\theta = \frac{\pi}{2}$ (fig. 2c red trace) provides information on the degree of indistinguishability between the two paths of the interferometer and on the phase of the superposition in eq. (1). We extract a visibility $V_{\theta=\pi/2} = 76\%$ from the fit to the experimental data. The fact that this is less than $V_{\theta=0} = 93\%$, can be attributed to two factors (see SI for details). First, a small deviation of the phase ϕ_0 away from π would cause a loss of visibility (given our measurement settings). Our experimental data can be used to bound the phase $|\phi_0 - \pi| \leq 0.620$ rad. Second, a loss of visibility would also follow from temporal distinguishability, i.e. when the which-time information is not perfectly erased after the second pass through the unbalanced interferometer. We show in the SI that this effect can be modeled as a loss of purity of the entangled state, i.e. by the density matrix $\hat{\rho} = \lambda|\phi_-\rangle\langle\phi_-| + (1 - \lambda)\hat{\rho}_m$ where $\hat{\rho}_m = |E_s, E_a\rangle\langle E_s, E_a| + |L_s, L_a\rangle\langle L_s, L_a|$ is a mixed state. Assuming $\phi_0 = \pi$, our data is consistent with $\lambda \geq 0.814$.

Finally, from the temporal behavior of the CHSH parameter we can extract the rate of pure dephasing of the vibrational qubit mediating the Bell correlations. Using a dynamical model for the time-dependence of the CHSH parameter (see SI), in conjunction with the measured value of $g_{s,a}^{(2)}$ and the imperfections described above, we extract the pure dephasing rate (the only free parameter in the model) for the quantum superposition of the two vibrational time-bin modes. The model is plotted against the data of Fig. 2 (solid line), and the best agreement with the data is obtained with a pure dephasing rate

identically null (see SI for further comparisons). This agrees with previous measurements of the phonon coherence time in diamond using transient coherent ultrafast phonon spectroscopy [38] showing that the phonon coherence time is set by the population decay time.

IV. CONCLUSION

We have demonstrated for the first time that Bell correlations between two photons can be mediated by a mechanical vibration at room temperature. This was achieved using the generic and universal properties of the inelastic scattering of light by Raman-active vibrations. Remarkably, the quantum state of the vibrational mode is preserved for ~ 1000 times its oscillation period at room temperature, an order of magnitude improvement over prior reports [39]; in fact, expressed in terms of the oft-quoted ‘‘Q-frequency product’’ this corresponds to a record room temperature value of $Q \times f \approx 10^{16}$ Hz. Such highly coherent vibrational modes, together with the toolset of time-resolved single-photon Raman spectroscopy that we have demonstrated here, should allow to entangle two vibrational qubits via entanglement swapping [40], or to perform optomechanical conversion between photonic qubits at different frequencies [41], among other possible applications. Even much longer vibrational coherence times could be achieved with ensembles of molecules that are decoupled from the phonon bath by surface engineering [42] or optical trapping [43], for example. In the future, our scheme could be applied to individual molecules using the enhancement of light-vibration coupling offered by electronic resonances [44] or plasmonic [45] or optical micro-cavities [46], with the potential to reveal the coherence time of a vibrational qubit free of heterogeneous broadening. Other types of entanglement could also be explored by adapting our scheme, such as energy-domain entanglement between two vibrational modes of different frequencies [47] – which in turn could be used to access decoherence-free subspaces [48] of the vibrational Hilbert space – or multimodal entanglement [49] between several other degrees of freedom, including e.g. polarisation [20] or chirality [50]. Finally, in addition to being a benchmark for the robustness of Bell correlations in simple room-temperature systems, our demonstration provides a technique to precisely probe the role of phonon-mediated entanglement in quantum technologies [51], chemistry [52], and even biology [53].

V. ACKNOWLEDGEMENT

The authors thank T. J. Kippenberg for valuable discussion. This work was funded by the Swiss National Science Foundation (SNSF) (project number PP00P2-170684), and the European Research Council's (ERC) Horizon 2020 research and innovation programme (grant agreement No. 820196). N.S. acknowledges funding by

the Swiss National Science Foundation (SNSF), through the Grant PP00P2-179109 and 200021-175527, by the Army Research Laboratory Center for Distributed Quantum Information via the project SciNet and from the European Unions Horizon 2020 research and innovation programme under grant agreement No 820445 and project name Quantum Internet Alliance.

SUPPLEMENTARY INFORMATION

CONTENTS

A. Experimental details	7
1. Excitation pulses	7
2. Which-time information erasing	7
3. Impact of birefringence	8
4. Time-bin to polarisation qubit mapping	8
5. Detection	9
6. Optimisation	9
7. Calibration of the Variable Retarders	9
8. Data Acquisition	9
B. Theoretical model	10
1. Jones calculus to model the experiment	10
2. Corner density matrix	10
3. Unbalanced initial state	11
4. Pure initial state	11
a. Upper bound on unwanted phase	11
5. Initial state with a mixed component	13
a. Upper bound on mixed component	13
6. Pure dephasing	13
7. Loss of Visibility due to limited $g_{s,a}^{(2)}$	13
8. Extracting the rate of pure dephasing	14
C. Error Bars	14
D. Evaluation of the CHSH value from finite statistics	14
1. CHSH as a game	14
2. Confidence interval on the mean value of winning probability	15
3. Example calculation	15
References	16

Appendix A: Experimental details

The full schematic of the experimental setup is shown in Fig. 3. We summarize the key experimental parameters in Table I.

1. Excitation pulses

A mode-locked Ti:Sapph laser and a synchronously pumped optical parametric oscillator are used to generate the read and write pulses, respectively. The pulse durations are about 100 fs and 200 fs for the Ti:Sapph and OPO, respectively. The experiment is repeated every 12.5 ns, set by the 80 MHz repetition rate of the laser system. The linear polarisation of the write and read pulses are first rotated by 45 degrees so that half of their intensity is directed toward the two arms of the

Parameter	Value
Repetition Rate	80.7 MHz
Write pulse wavelength	695 nm
Stokes wavelength	766 nm
Read pulse wavelength	800 nm
Anti-Stokes wavelength	723 nm
Write pulse energy	25 pJ
Read pulse energy	248 pJ
Total acquisition time per setting	4 min
Average Stokes countrate*	35700 s ⁻¹
Average anti-Stokes countrate*	1750 s ⁻¹
Stokes - anti-Stokes coincidence rate*•	17 s ⁻¹

TABLE I. Summary of relevant experimental parameters.

* Calculated using the total countrate of + and - detectors in each detection arm.

• For a delay $\Delta t = 0.66$ ps.

unbalanced interferometer, which is constructed with polarising beam splitters. Light that is vertically polarized travels through the short path, while horizontally polarized light travels through the long path. A half-wave plate rotates the polarisation of all pulses by 90 degrees after the interferometer, yielding the pulse distribution shown in Fig. 1b of the main text, where the layout was unfolded and modified for clarity. The delay between the two arms of the unbalanced interferometer is about 3 ns (approximately 1 m in free space), orders-of-magnitude longer than the phonon lifetime in the sample (≈ 4 ps).

2. Which-time information erasing

The time-bin entangled state is prepared by erasing temporal information about the Raman scattering processes. To do so, after the sample the Raman scattered photons are collected in transmission and passed through the same polarisation-selective unbalanced interferometer as the one used to create the two time bins in excitation, but they enter from another input port.

By suitably rotating the polarisation of the incoming pulses and of the Raman scattered photons, which are related by the symmetry of the vibrational mode under study, we can optimise the likelihood for the Raman photons to temporally overlap after the second interferometer. This is achieved when Raman scattered photons from the early time-bin are routed in the long arm, and vice-versa. Due to the linear polarisation of the Raman scattered fields in our geometry, this likelihood is close to unity (note that for diamond excited along the [100] crystal axis the Raman scattered photons are orthogonally polarised with respect to the pump).

In the worst-case scenario where Raman photons are unpolarised, half of them would take the wrong path and remain distinguishable in time. Accordingly, the like-

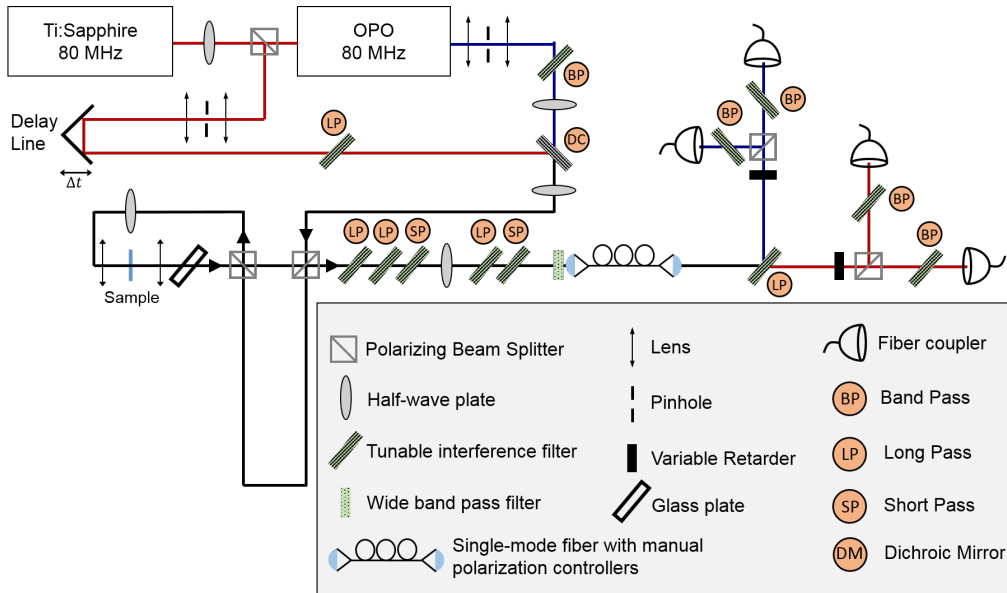

FIG. 3. **Experimental Setup**

hood to erase which-time information would drop to one fourth (25%); but the fidelity of the post-selected entangled state would not be affected. Indeed, as long as the time-bin separation is larger than the detector jitter, temporal filtering can be performed to exclude the distinguishable events from analysis. It is worth mentioning here that crystals and molecules with different symmetries may allow for the storage of polarisation-encoded vibrational qubits, therefore opening new experimental possibilities to probe photon-phonon entanglement [50].

Additionally, using the same physical interferometer twice - first to define the time bins in excitation and then to erase the temporal information carried by the Raman scattered photons - renders our entire setup passively phase-stable, as any fluctuation of the optical path between two arms occurring on a time scale longer than the travel time for light through the setup (which is a few tens of nanoseconds) is cancelled by construction (see detailed layout in SI). In this way, we are insensitive to all types of noise causing path fluctuations in a bandwidth of at least 10 MHz, which encompasses almost all mechanical and thermal instability.

3. Impact of birefringence

Special care must be taken to avoid birefringence in the setup, as it would result in a temporal shift between the horizontal (H) and vertical (V) polarisations. Imperfect temporal overlap translates into a mixed state component as opposed to a pure entangled state (see Sec. B). The short duration of the laser pulses means that the overlap must be preserved to well below 100 fs, and this must be the case for a relatively broad wavelength range of several tens of nm.

Dichroic mirrors and tunable interference filters in particular have a strong birefringence when the incident angle is non zero. We mitigate the birefringence induced delay caused by the dichroic mirror that serves to overlap the write and read pulses on the same spatial mode by preparing both beams in the vertical polarisation, and then using an achromatic half wave plate to rotate the polarisation by 45 degrees before the imbalanced polarised interferometer.

Also, we must mitigate the deleterious effect of birefringence in the interference filters used to reject the write and read laser beams. For this, we use two identical sets (consisting each of a long pass filter to block the write pulse and a short filter to block the read pulse) and place an achromatic half wave plate between them. In this way, the Raman scattered light goes through the second sets of filters after its polarisation was rotated by 90 degrees, so that we ensure that both polarisations are equally delayed even in the presence of birefringence, and thus the temporal and spatial overlap is perfectly maintained.

4. Time-bin to polarisation qubit mapping

Since we use polarising beam splitters to route the photons in the short and long path of the unbalanced interferometer, the polarisation is the only degree of freedom that distinguishes between the early and late time bin after the Stokes and anti-Stokes photons are temporally overlapped. More specifically, Raman photons originating from the early time are vertically polarised, and those from the late time bin are horizontally polarised.

5. Detection

After the laser rejection filters, the Raman signal is spatially filtered by coupling it into a S630-HP single mode fiber (Thorlabs, FC/PC). Polarisation control paddles are used to maintain the same linear polarisation before and after the fiber. The signal is collimated after the fiber and sent onto a tunable long pass filter, where the Stokes field is transmitted and the anti-Stokes field is reflected, after which the two fields enter the two detection apparatuses labelled ‘Alice’ and ‘Bob’, respectively. The birefringence introduced by this filter - especially for the reflected beam, which has a very strong wavelength and angle dependence - cannot be easily compensated, and we attribute the main loss of visibility to this element.

At each locations we first use a variable retarder (VR), whose fast axis is rotated by 45 degrees with respect to the vertical, in order to perform the state rotation (see Sec. B for the mathematical formalism). Subsequently, a polarising beam splitter (PBS) directs the horizontal (H) and vertical (V) components of the incoming light onto two distinct single photon detectors, implementing thereby a projective measurement in the H/V basis, equivalent to the early/late basis for the time bin qubits. After these last PBS, birefringence no longer affects the experiment, and we send the output of each PBS through a tunable bandpass filter centered on the Stokes or anti-Stokes wavelengths, respectively. Finally, we couple each of the four output beams into a multi-mode fiber connected to an avalanche photo diode (APD) operated in Geiger mode, featuring about 50% detection efficiency and 500 ps timing jitter.

6. Optimisation

Before running the experiment we check the two-photon correlations in the $\{\theta = 0, \varphi = 0\}$ and $\{\theta = \frac{\pi}{2}, \varphi = \frac{\pi}{2}\}$ configurations, where θ (resp. φ) is the state rotation angle (given by the retardation of the variable retarder) chosen by Alice (resp. Bob). Under ideal conditions we would expect $E(0,0) = E(\frac{\pi}{2}, \frac{\pi}{2})$, but we always measure $E(0,0) > E(\frac{\pi}{2}, \frac{\pi}{2})$ due to either imperfect alignment or birefringence that was not properly compensated for (see mathematical explanation in Sec. B). As a final step we slightly change the angle of the first long pass filter after the interferometer to maximize the value of $E(\frac{\pi}{2}, \frac{\pi}{2})$.

7. Calibration of the Variable Retarders

The liquid crystal variable retarders (VR) (from AR-Coptix) allow us to apply a voltage-dependent delay along one polarisation axis. This axis is set to 45 deg, allowing us to rotate the polarisation state of each photon in a plane containing the vertical and horizontal states (see Sec. B).

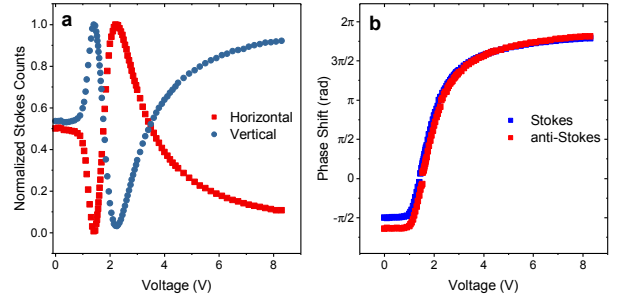

FIG. 4. **Calibration of variable retarders** **a**, Normalized count rates on the detectors measuring the vertical and horizontal components of the light after the VR, when vertically polarised light is sent into the VR. Data for the Stokes channel only are shown. **b**, Extracted voltage-dependent phase shifts for the Stokes and anti-Stokes wavelengths.

To avoid any artefact due to the wavelength dependence of the retardation, the calibration of the VRs at Alice and Bob’s locations is done with the Stokes or anti-Stokes signals, respectively, by sending vertically polarised light through the VR and measuring the amount of vertically and horizontally polarised light afterwards using a PBS and two detectors. The phase shift is then $\delta = \arccos(2T - 1)$, where T is the normalized count rate in the vertical polarisation detector. Results of this procedure are shown in Fig. 4.

8. Data Acquisition

We record the detection events using a custom time-tagging card developed by the Digital Electronics Laboratory at Politecnico di Milano (Prof. Angelo Geraci) with four input channels plus a sync channel. Using the sync signal from the mode-locked laser oscillator as a time reference, we define a detection time window that only records photons originating from the early time bin and taking the long path in the second interferometer, or vice versa (from late time bin taking the short path). We discard all other events. Over the acquisition time, we record the number of single detection events from each detector occurring in the detection window, as well as the number of times multiple detectors clicked during the same window. The number of coincidences between the detectors of Alice and Bob correspond to the $n_{\pm, \pm}$ terms used to calculate E . We obtain the two-photon interference curves of Fig. 2 (main text) at a fixed write-read delay by setting $\theta = 0$ or $(\theta = \frac{\pi}{2})$ and sweeping φ .

We ran the Bell tests with the phase setting $\{\theta, \varphi\}$ in the following order: $\{0, \frac{\pi}{4}\}$, $\{0, -\frac{\pi}{4}\}$, $\{\frac{\pi}{2}, \frac{\pi}{4}\}$, $\{\frac{\pi}{2}, -\frac{\pi}{4}\}$. We measure for 1 minute at each phase setting before changing the delay between write and read pulses, which is moved from negative to positive delay. In order to mitigate systematic errors (drifts in alignment, for example),

we repeat the whole measurement sequence four times, for a total of four minutes per measurement setting at each delay setting. For the analysis all the counts of the four measurements with the same setting are added together, and used to compute E and S as explained in the main text.

The value of $g_{s,a}^{(2)}(\Delta t)$ is calculated as

$$g_{s,a}^{(2)} = \frac{P(s \cap a)}{P(s)P(a)} = \frac{n_{s \cap a} \cdot R}{n_s \cdot n_a} \quad (\text{A1})$$

where R is the number of times the experiment was run (the repetition rate of the laser system times the acquisition time), n_s is the total number of Stokes photons detected (in the appropriate time window), n_a is the total number of anti-Stokes photons detected, and $n_{s \cap a}$ is the total number of coincidences between Stokes and anti-Stokes photons, i.e. $n_{(s \cap a)} = n_{++} + n_{+-} + n_{-+} + n_{--}$.

Appendix B: Theoretical model

In this section we explain how we model the experiment in order to obtain the fitting function for the CHSH parameter plotted in Fig. 2 of the main text. We first use Jones calculus to find the effect of the optical elements on the quantum state of the Stokes–anti-Stokes photon pair. We then consider how an ideal Bell state is modified by the inclusion of the most relevant experimental imperfections.

To make the link between optical elements and the corresponding mathematical operations more explicit, we describe the two time-bin modes in term of the associated polarisation of the Raman photons through the mapping implemented by the polarisation selective unbalanced interferometer: $|E_s\rangle \rightarrow |V_s\rangle$; $|E_a\rangle \rightarrow |V_a\rangle$ and $|L_s\rangle \rightarrow |H_s\rangle$; $|L_a\rangle \rightarrow |H_a\rangle$.

1. Jones calculus to model the experiment

We use Jones calculus to find the operators representing the optical elements (VR and PBS) in the reduced Hilbert space with exactly one photon existing in two possible polarisations. Specifically, a variable retarder with the retardation axis along the vertical axis is represented by (up to a global phase)

$$M_{VR}(\theta) = \begin{pmatrix} e^{-i\theta/2} & 0 \\ 0 & e^{i\theta/2} \end{pmatrix} \quad (\text{B1})$$

where θ is the phase retardation introduced between vertical and horizontal components. We also define the matrix for a polarizer M_{P+} with the transmission axis along the vertical direction, and a polarizer M_{P-} with the transmission axis along the horizontal direction as

$$M_{P+} = \begin{pmatrix} 0 & 0 \\ 0 & 1 \end{pmatrix} \quad M_{P-} = \begin{pmatrix} 1 & 0 \\ 0 & 0 \end{pmatrix} \quad (\text{B2})$$

The matrix for a variable retarder oriented at an arbitrary angle α with respect to vertical are then given by $M_{VR}^\alpha(\theta) = R(-\alpha)M_{VR}(\theta)R(\alpha)$, where $R(\alpha)$ is the rotation matrix

$$R(\alpha) = \begin{pmatrix} \cos(\alpha) & \sin(\alpha) \\ -\sin(\alpha) & \cos(\alpha) \end{pmatrix} \quad (\text{B3})$$

We then find the total operator (in the Hilbert space with exactly one Stokes and one anti-Stokes photon) for the two variable retarders at 45° ($\frac{\pi}{4}$ rad) acting on the Stokes and anti-Stokes fields by taking the tensor product

$$M_{VR}(\theta, \varphi) = M_{VR}^{\frac{\pi}{4}}(\theta) \otimes M_{VR}^{\frac{\pi}{4}}(\varphi) \quad (\text{B4})$$

The state after going through the variable retarders is transformed according to

$$\hat{\rho}_{out} = M_{VR}(\theta, \varphi) \hat{\rho}_{in} M_{VR}(\theta, \varphi)^\dagger \quad (\text{B5})$$

We define $M_{P_{xy}}$ as the operator for a polarizer with the transmission along the x axis for the Stokes field and y axis for the anti-Stokes field. For example, $M_{P_{-+}}$ is defined as $M_{P_{-+}} \equiv M_{P_-} \otimes M_{P_+}$.

We can then compute the expectation values of relevant observables for assessing the CHSH parameter, i.e. $n_{xy} = Tr(\hat{\rho}_{out} M_{P_{xy}})$. With the n_{xy} coefficients we can then calculate the correlation parameters as explained in the main text.

2. Corner density matrix

We present here the analytical solution for a special case that will appear multiple times in this section. We consider the case of a density matrix that only has non-zero elements in the corners, i.e.

$$\hat{\rho} = \begin{pmatrix} x_{11} & 0 & 0 & x_{14} \\ 0 & 0 & 0 & 0 \\ 0 & 0 & 0 & 0 \\ x_{41} & 0 & 0 & x_{44} \end{pmatrix} \quad (\text{B6})$$

corresponding to $\hat{\rho} = x_{11}|H_s H_a\rangle\langle H_s H_a| + x_{44}|V_s V_a\rangle\langle V_s V_a| + x_{14}|H_s H_a\rangle\langle V_s V_a| + x_{41}|V_s V_a\rangle\langle H_s H_a|$.

By using the methodology described above, we find that the values of the correlation parameters are

$$\begin{aligned} E\left(0, \frac{\pi}{4}\right) &= \frac{1}{\sqrt{2}} \\ E\left(0, -\frac{\pi}{4}\right) &= \frac{1}{\sqrt{2}} \\ E\left(\frac{\pi}{2}, \frac{\pi}{4}\right) &= -\frac{1}{\sqrt{2}} \left(\frac{x_{14} + x_{41}}{x_{11} + x_{44}} \right) \\ E\left(\frac{\pi}{2}, -\frac{\pi}{4}\right) &= \frac{1}{\sqrt{2}} \left(\frac{x_{14} + x_{41}}{x_{11} + x_{44}} \right) \end{aligned} \quad (\text{B7})$$

And the visibility curves at $\theta = 0$ and $\theta = \pi/2$ are given by

$$\begin{aligned} E(0, \varphi) &= \cos(\varphi) \\ E(\pi/2, \varphi) &= -\sin(\varphi) \begin{pmatrix} x_{14} + x_{41} \\ x_{11} + x_{44} \end{pmatrix} \end{aligned} \quad (\text{B8})$$

These expressions simplify further considering that $x_{11} + x_{44} = \text{Tr}(\hat{\rho}) = 1$ for a density matrix. We can clearly see that a density matrix of this form will always have ideal visibility of unity for the $\theta = 0$ curve, while the visibility of the $\theta = \pi/2$ curve will depend on the off diagonal elements.

3. Unbalanced initial state

We first analyze the effect of having different weights between the two elements of a Bell state, i.e. $|\psi\rangle = \frac{1}{\sqrt{2}}(\sqrt{1+\epsilon}|H_s H_a\rangle - \sqrt{1-\epsilon}|V_s V_a\rangle)$, where ϵ gives the imbalance between them. This state has the form described in section B2, and therefore

$$\begin{aligned} E\left(\frac{\pi}{2}, \frac{\pi}{4}\right) &= -\frac{1}{\sqrt{2}}\sqrt{1-\epsilon^2} \\ E\left(\frac{\pi}{2}, -\frac{\pi}{4}\right) &= \frac{1}{\sqrt{2}}\sqrt{1-\epsilon^2} \end{aligned} \quad (\text{B9})$$

An unequal splitting of power in our experiment, which leads to this type of asymmetry, will therefore reduce the visibility of the correlations when $\varphi = \pi/2$. It will also affect the measurement of the marginal state, and we use this in order to find our experimental ϵ .

The marginal of this state is represented by $\hat{\rho}_a = \frac{1+\epsilon}{2}|H_a\rangle\langle H_a| + \frac{1-\epsilon}{2}|V_a\rangle\langle V_a|$. We calculate the difference between the expectation values at the two outputs of the measurement system,

$$\langle M_{P+} \rangle - \langle M_{P-} \rangle = \epsilon \cos(\varphi) \quad (\text{B10})$$

and fit this function to the difference between normalized count rates shown in Figure 2b of the main text. We find that for our experiment $\epsilon = 0.027$, which leads to a loss of visibility of 0.04%. In the following analysis we neglect this contribution.

4. Pure initial state

We consider the pure entangled (and Bell correlated) state $|\psi\rangle = \frac{1}{\sqrt{2}}(|H_s H_a\rangle + e^{i\phi}|V_s V_a\rangle)$, which is represented by the density matrix $\hat{\rho} = |\psi\rangle\langle\psi|$ of the type described in section B2, and therefore

$$\begin{aligned} E\left(\frac{\pi}{2}, \frac{\pi}{4}\right) &= -\frac{1}{\sqrt{2}}\cos(\phi) \\ E\left(\frac{\pi}{2}, -\frac{\pi}{4}\right) &= \frac{1}{\sqrt{2}}\cos(\phi) \end{aligned} \quad (\text{B11})$$

In our experiment ϕ , the accumulated phase difference between the early and late states, could arise from differences in path lengths within the folded interferometer, or from birefringence in the optical elements (as discussed above). For the chosen measurement basis and settings, the maximum Bell inequality violation will be found with $\phi = 0$ or $\phi = \pi$. When experimentally optimising the visibility of the two-photon interference, we choose to set the phase to $\phi = \pi$.

The visibility of the correlation parameter for $\theta = \pi/2$ is determined by $\cos(\phi)$. This means that any deviation from $\phi = 0$ or $\phi = \pi$ translates into a reduced visibility of the two photon interference curve with $\theta = \pi/2$, compared to that with $\theta = 0$, as shown in Fig. 6. We can also discriminate between the states with $\phi = 0$ or $\phi = \pi$ by considering in which direction the curve obtained with $\theta = \pi/2$ shifts compared to the one at $\theta = 0$, as illustrated in Fig. 5. By comparing with Fig. 2 of the main text we can claim that we are preparing a state close to $|\Psi\rangle = \frac{1}{\sqrt{2}}(|H_s H_a\rangle - |V_s V_a\rangle) \equiv |\phi_-\rangle$.

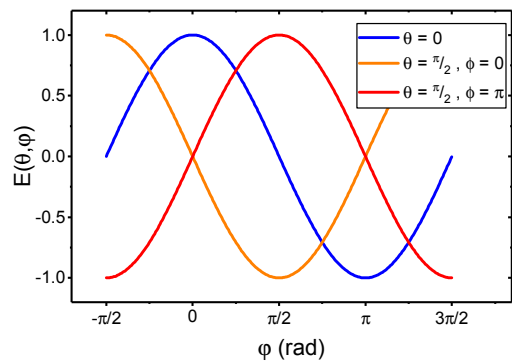

FIG. 5. Calculated curves for the correlation parameter E inferred from a quantum state of the form $|\psi\rangle = \frac{1}{\sqrt{2}}(|H_s H_a\rangle + e^{i\phi}|V_s V_a\rangle)$, with different values of ϕ . The curve obtained for $\theta = 0$ does not depend on the phase ϕ , while the curves computed for $\theta = \pi/2$ let us distinguish $|H_s H_a\rangle + |V_s V_a\rangle$ from $|H_s H_a\rangle - |V_s V_a\rangle$.

a. Upper bound on unwanted phase

In the experiment we observe a ratio between the two-photon interference visibility at $\theta = \pi/2$ and that at $\theta = 0$ of 0.814. If we attribute all the loss of visibility to a phase deviating away from $\phi = \pi$ (assuming perfect temporal overlap and therefore pure state) we find that the phase must be within $\phi = \pi \pm 0.620$ rad to be able to reproduce our results.

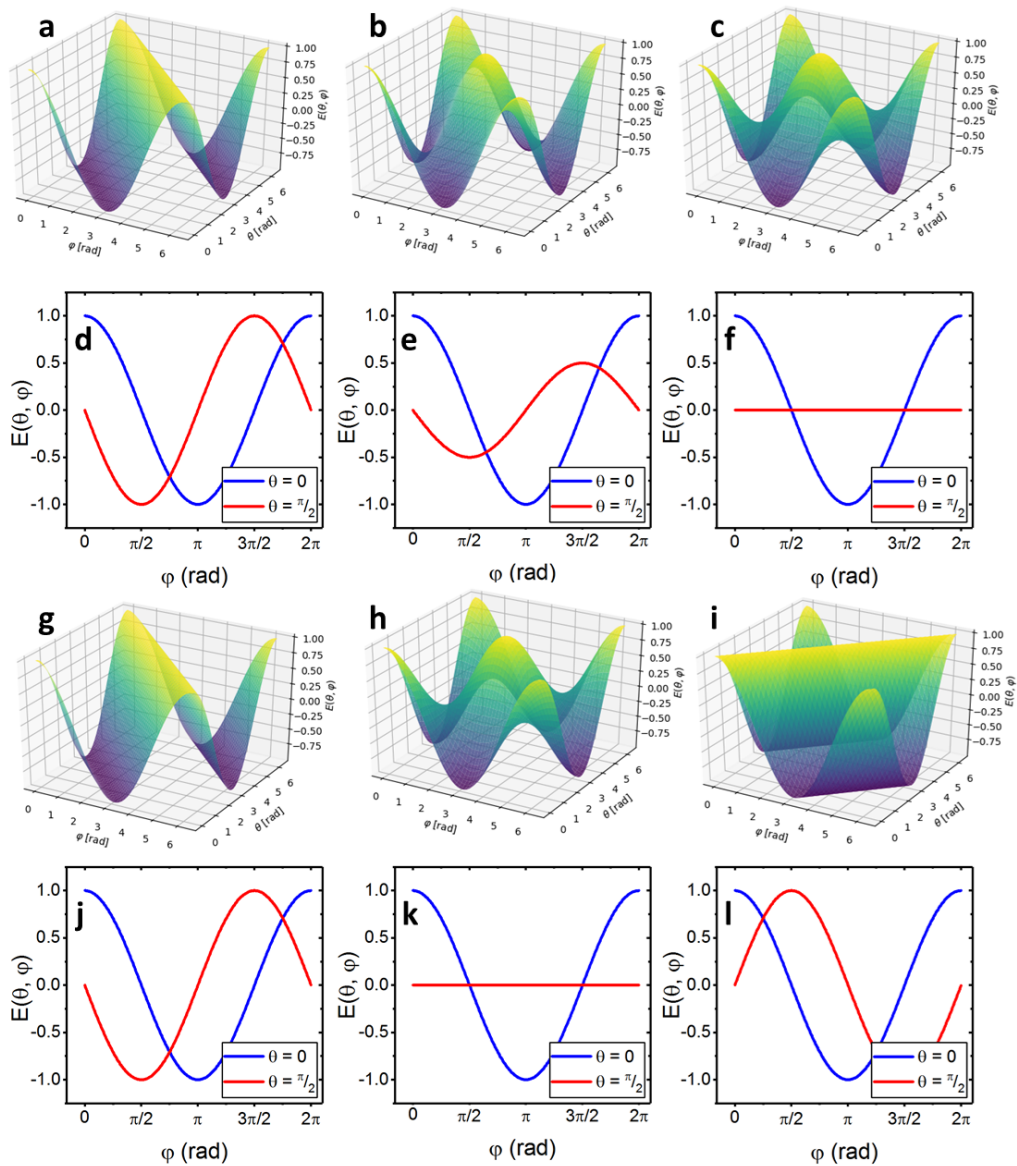

FIG. 6. **Computed two-photon coincidence curves.** Panels **a-c** show the value of the correlation parameter E for the density matrix $\hat{\rho} = \lambda|\phi_{-}\rangle\langle\phi_{-}| + (1 - \lambda)\hat{\rho}_m$ (see text). In **a**, $\lambda = 1$ (pure state), while in **b**, $\lambda = 1/2$ (partially mixed state), and in **c**, $\lambda = 0$ (fully mixed state). The panels **d-f** show cuts at $\theta = 0$ and $\theta = \pi/2$ for the surface plots above them. Panels **g-i** show the value of the correlation parameter E for the pure state $|\psi\rangle = \frac{1}{\sqrt{2}}(|H_s, H_a\rangle + e^{i\phi}|V_s, V_a\rangle)$. In **g**, $\phi = 0$, while in **h**, $\phi = \pi/2$, and in **i**, $\phi = \pi$. Panels **j-l** again show cuts at $\theta = 0$ and $\theta = \pi/2$ for the surface plots above them.

5. Initial state with a mixed component

Another effect that can lead to a loss of visibility is an imperfect overlap after the second pass through the interferometer. If it does not perfectly undo the delay introduced by the first pass, the photons will not be perfectly indistinguishable in their temporal modes. This imperfect temporal overlap is too short for our detectors to resolve, but it makes partial information about the time bin of origin of the photons in principle available. This results in a mixed state as opposed to a pure entangled state. By mapping the time bin degree of freedom to polarisation, our scheme produces pairs of photons that are either vertically or horizontally polarized before being overlapped. Therefore, we can write the general density matrix

$$\hat{\rho} = \lambda|\psi\rangle\langle\psi| + (1 - \lambda)\hat{\rho}_m$$

as a sum of the pure entangled state

$$|\psi\rangle = \frac{1}{\sqrt{2}}(|H_s H_a\rangle + e^{i\phi}|V_s V_a\rangle)$$

and a mixed state

$$\hat{\rho}_m = |H_s H_a\rangle\langle H_s H_a| + |V_s V_a\rangle\langle V_s V_a|$$

which results from the non-overlapping temporal modes.

This again leads to the case described in Sec. B2, with the correlation parameter for a fixed $\theta = \pi/2$ being expressed by $E(\pi/2, \varphi) = -\lambda \cos(\phi) \sin(\varphi)$. Any mixed component from imperfect temporal overlap will therefore decrease the visibility, and the maximum CHSH parameter will only be obtained for the pure entangled state.

Experimentally, we cannot discriminate between the effect of an incorrect phase $\phi \neq \pi$ that was discussed in Sec. B4, and imperfect temporal overlap. The two could in principle be distinguished by changing the measurement basis to one in which $\phi = \pi/2$ gives a maximum CHSH violation, which would allow us to quantify the contribution of each effect. This would however entail a change in setup configuration and therefore in temporal overlap, so it is unlikely to yield a definite answer.

With this complete model, we obtain the correlation parameters for the settings used to compute the CHSH parameter

$$\begin{aligned} E\left(0, \frac{\pi}{4}\right) &= E\left(0, -\frac{\pi}{4}\right) = \frac{1}{\sqrt{2}} \\ E\left(\frac{\pi}{2}, \frac{\pi}{4}\right) &= -\frac{1}{\sqrt{2}}\lambda \cos(\phi) \\ E\left(\frac{\pi}{2}, -\frac{\pi}{4}\right) &= \frac{1}{\sqrt{2}}\lambda \cos(\phi) \end{aligned} \quad (\text{B12})$$

From which we derive the CHSH parameter

$$S = \sqrt{2}(1 + V_0) \quad (\text{B13})$$

where $V_0 = \lambda \cos(\phi)$ is the loss of visibility due to the imperfect phase and temporal overlap, which is measured experimentally as the ratio of the amplitudes of the visibility curves at $\theta = \pi/2$ and $\theta = 0$.

a. Upper bound on mixed component

By considering the case in which all the loss of visibility between the $\theta = 0$ and the $\theta = \pi/2$ curve is due to a mixed component in the state, we can obtain a lower bound on the purity of the state. This lower bound is $\lambda = 0.814$.

6. Pure dephasing

To introduce the pure dephasing rate we consider the state $|\psi\rangle = \frac{1}{\sqrt{2}}(|H_s, H_a\rangle + e^{i\phi}|V_s, V_a\rangle)$, where the phase ϕ is a random variable for each repetition of the experiment. Given the large number of repetitions, we model ϕ as being drawn from a Gaussian distribution,

$$p(\phi) = \frac{\exp[-(\phi - \phi_0)^2/2\sigma^2]}{\sqrt{2\pi\sigma^2}}, \quad (\text{B14})$$

where ϕ_0 is the mean phase, and $\sigma = \sqrt{\gamma\Delta t}$ is the standard deviation – depending on the dephasing rate γ , and the time duration Δt – exhibiting the $\sqrt{\Delta t}$ dependence of a diffusing phase.

The measured state, averaged over the random phases, is,

$$\begin{aligned} \rho &= \frac{1}{2}|H_s H_a\rangle\langle H_s H_a| + \frac{1}{2}|V_s V_a\rangle\langle V_s V_a| \\ &\quad + \frac{1}{2} \int d\phi e^{-i\phi} p(\phi) |H_s H_a\rangle\langle V_s V_a| \\ &\quad + \frac{1}{2} \int d\phi e^{i\phi} p(\phi) |V_s V_a\rangle\langle H_s H_a| \\ &= \frac{1}{2}|H_s H_a\rangle\langle H_s H_a| + \frac{1}{2}|V_s V_a\rangle\langle V_s V_a| \\ &\quad + \frac{e^{-\sigma^2/2}}{2} [e^{-i\phi_0} |H_s H_a\rangle\langle V_s V_a| \\ &\quad + e^{i\phi_0} |V_s V_a\rangle\langle H_s H_a|]. \end{aligned} \quad (\text{B15})$$

From this expression we can compute the CHSH parameter

$$S = \frac{2\sqrt{2}}{2}(1 + V_0 e^{-\gamma\Delta t/2}). \quad (\text{B16})$$

7. Loss of Visibility due to limited $g_{s,a}^{(2)}$

The previous sections had assumed the perfect preparation of the states (i.e. $|L_s L_a\rangle$ and $|V_s V_a\rangle$), but in practice there is a non-zero probability of creating states

where the two photons have different polarisation (i.e. originates from two different time bins).

Until now, we have ignored noise photons in the anti-Stokes channel coming from the thermal phonon bath and other nonlinear effects in the sample, as well as multiple pair creation in the Stokes process. These events are responsible for a reduction in the normalised Stokes – anti-Stokes cross-correlation $g_{s,a}^{(2)}$, which is also called the coincidence-to-accidental ratio.

Under the assumption that the probabilities of correctly recording anti-Stokes photons created in the early vs. late time bin are the same, the two-photon interference visibility is bounded by the cross-correlation parameter by [37]

$$V_{max} = \frac{g_{s,a}^{(2)} - 1}{g_{s,a}^{(2)} + 1} \quad (\text{B17})$$

This sets an upper bound to the visibility due to noise photons, and leads to the final expression of the CHSH parameter including all effects considered above:

$$S = \frac{2\sqrt{2}}{2} V_{max} (1 + V_0 e^{-\gamma \Delta t / 2}) \quad (\text{B18})$$

8. Extracting the rate of pure dephasing

We fit the measured $g_{s,a}^{(2)}(\Delta t)$ using a single exponential decay with time constant $\tau = 3.78$ ps, convoluted with the instrument response function (Gaussian of width 200 fs). We then use eq. (B18) to produce the expected curve for $S(\Delta t)$, with $V_0 = 0.814$ as experimentally determined above. The rate of pure dephasing is an adjustable, a priori unknown parameter.

In Fig. 7, we compare the measured CHSH parameter with the formula eq. B18 for various different dephasing rates (γ). The best agreement with the experimental data is found for $\gamma \ll \tau^{-1}$, consistent with a lifetime-limited coherence time.

Appendix C: Error Bars

The error bars displayed on all experimental plots for the normalised correlation parameter E and CHSH parameter S are calculated using a Monte Carlo approach. For each measurement we model the probability of each coincidence count n_{xx} as a Poissonian distribution centered on n_{xx} . We then pick a random number from each distribution using the Python library NumPy, and use it to calculate S (resp. E) for the Bell measurement (resp. visibility measurement). We repeat this process many times in order to obtain a collection of values for S (resp. E), and we take the standard deviation of this distribution to be a faithful estimate for the statistical uncertainty of the measurement.

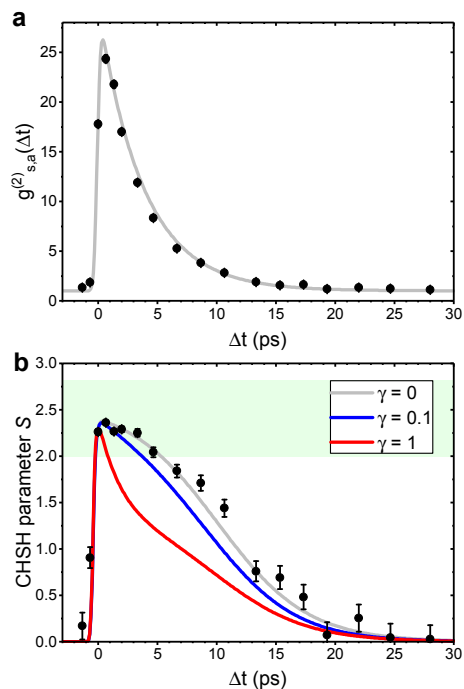

FIG. 7. **a**, Experimentally measured normalised Stokes–anti-Stokes cross-correlation $g_{s,a}^{(2)}(\Delta t)$ vs. the write–read time delay Δt , together with an exponential fit with a decay time constant $\tau = 3.78$ ps, corresponding to the phonon lifetime. **b**, Experimental CHSH parameter (as in main text, Fig. 2) overlaid with the curves computed from eq. (B18) with the expression for $g_{s,a}^{(2)}(\Delta t)$ from panel **a**. Different values of the pure dephasing rate are shown, illustrating that our data are consistent with the decoherence of the vibrational qubit being dictated by population decay. The green region, demarcated by $2 < |S| \leq 2\sqrt{2}$, certifies Bell correlations.

To ensure convergence of the procedure, after each iteration described above, we compare the average and standard deviation of the accumulated values to the results from the previous step. We keep repeating this process until the relative difference between two successive steps is below 10^{-5} for both the average and standard deviation.

Appendix D: Evaluation of the CHSH value from finite statistics

1. CHSH as a game

In a CHSH test, Alice receives at each run a random bit $x = \{0, 1\}$ and similarly for Bob $y = \{0, 1\}$. When Alice gets x , she chooses the measurement setting A_x while Bob chooses B_y . For each setting choice, they receive a result $a = \{0, 1\}$ for Alice and $b = \{0, 1\}$ for Bob. They repeat the experiment many times so that they can evaluate

$$\langle A_x B_y \rangle = p(a = b | A_x B_y) - p(a \neq b | A_x B_y). \quad (\text{D1})$$

The CHSH value is given by

$$S = \langle A_0 B_0 \rangle + \langle A_0 B_1 \rangle + \langle A_1 B_0 \rangle - \langle A_1 B_1 \rangle. \quad (\text{D2})$$

Such a test can be phrased as a game in which Alice and Bob receive x and y , respectively, as inputs and the winning condition is that their outputs satisfy $a \oplus b = x \cdot y$ where \oplus is the sum modulo 2. The winning probability q relates to the CHSH value S by

$$q = \frac{4 + S}{8}. \quad (\text{D3})$$

2. Confidence interval on the mean value of winning probability

Let us see each experimental run as if a random variable T_i was given. As an estimator of such a random

variable T_i , we choose

$$T_i = \chi(a_i \oplus b_i = x_i \cdot y_i) \quad (\text{D4})$$

with χ the indicator function, i.e. $\chi(\text{condition}) = 1$ if the condition is satisfied and 0 otherwise. Here a_i is the result of Alice at run i and similarly, b_i , x_i and y_i . Note that this estimator is unbiased. Indeed

$$\begin{aligned} \mathbf{E}(T_i) &= \sum_{a_i, b_i, x_i, y_i} T_i p(a_i, b_i, x_i, y_i) \\ &= \sum_{a_i, b_i, x_i, y_i} T_i p(a_i, b_i, x_i, y_i) \\ &= \sum_{a_i, b_i, x_i, y_i} T_i p(a_i, b_i | x_i, y_i) p(x_i, y_i) \end{aligned}$$

and since $p(x_i, y_i) = 1/4$,

$$\begin{aligned} \mathbf{E}(T_i) &= \frac{1}{4} \sum_{a_i, b_i, x_i, y_i} T_i p(a_i, b_i | x_i, y_i) \\ &= \frac{1}{4} (p(a_i = b_i = 0 | x_i \neq 1 \text{ and } y_i \neq 1) + p(a_i = b_i = 1 | x_i \neq 1 \text{ and } y_i \neq 1) \\ &\quad + p(a_i = 0, b_i = 1 | x_i = y_i = 1) + p(a_i = 1, b_i = 0 | x_i = y_i = 1)). \end{aligned}$$

Note that

$$\begin{aligned} p(a_i \oplus b_i = 0 | x_i, y_i) &= p(a_i = b_i = 0 | x_i, y_i) + p(a_i = b_i = 1 | x_i, y_i) = \frac{1}{2} (1 + \langle A_{x_i} B_{y_i} \rangle) \\ p(a_i \oplus b_i = 1 | x_i, y_i) &= p(a_i = 0, b_i = 1 | x_i, y_i) + p(a_i = 1, b_i = 0 | x_i, y_i) = \frac{1}{2} (1 - \langle A_{x_i} B_{y_i} \rangle) \end{aligned}$$

Therefore

$$\mathbf{E}(T_i) = \frac{1}{4} \left(\frac{4 + S_i}{2} \right) = q_i \quad (\text{D5})$$

that is, the expectation of T_i corresponds to the probability to win the game at run i . We want to bound the average winning probability $\bar{q} = \frac{1}{n} \sum_i q_i$. It was shown in Ref. [36] that $[q_{\min}, 1]$ is a confidence interval for \bar{q} with

$$q_{\min} = I_{\alpha}^{-1}(n\bar{T}, n(1 - \bar{T}) + 1) \text{ with } \bar{T} = \frac{1}{n} \sum_i T_i \quad (\text{D6})$$

where $0 \leq \alpha \leq 1/2$ is the confidence level (e.g. $\alpha = 0.01$ corresponds to a confidence level of 99%). Here we defined the inverse regularized incomplete Beta function I^{-1} , i.e. $I_y(a, b) = x$ for $y = I_x^{-1}(a, b)$.

Given a target confidence level α , the previous formula can be used to give a lower bound S_{\min} on the actual value of \bar{S} using the following steps :

- 1 - Compute T_i at each run using $T_i = \chi(a_i + b_i = x_i \cdot y_i)$
- 2 - Deduce $\bar{T} = (\sum_i T_i)/n$

3 - Compute q_{\min} from the eq. (D6) (for example with $\alpha = 0.01$ for a confidence level of 99%)

4 - Deduce the lower bound S_{\min} on the mean CHSH value $\bar{S} = \frac{1}{n} \sum_i S_i$ using $S_{\min} = 8q_{\min} - 4$.

3. Example calculation

We now show in detail the calculation for $\Delta t = 0.66$ ps. We have $A_x = \{\theta = 0, \theta = \pi/2\}$ and $B_y = \{\varphi = -\pi/4, \pi/4\}$ as the settings for the experiment, and $a, b = 0$ corresponds to a click in the + detector, while $a, b = 1$ corresponds to either a click in the - detector or the simultaneous clicking of both + and - detectors on one side (two-photon event).

We observe the following coincidences during the experiment:

Setting	n_{++}	n_{+-}	n_{-+}	n_{--}	$n_{\pm+}$	$n_{\pm-}$
$\theta = 0, \varphi = -\pi/4$	1301	270	458	2034	0	0
$\theta = 0, \varphi = \pi/4$	1338	229	460	2006	1	0
$\theta = \pi/2, \varphi = -\pi/4$	388	1408	1549	694	0	1
$\theta = \pi/2, \varphi = \pi/4$	1468	494	328	1781	1	0

Where $n_{\pm x}$ denotes the events involving two simultaneous coincidences in the Stokes measurement arm. There were no recorded events with simultaneous detections in

the anti-Stokes arm.

We use this data to calculate $\bar{T} = 0.785$. We then compute q_{\min} for $\alpha = 0.01$ (99% confidence) and $\alpha = 5.733 \times 10^{-7}$ (5σ confidence) using (D6), and obtain $q_{\min} = 0.788$ and $q_{\min} = 0.779$, respectively.

From this we conclude that the lower bound on \bar{S} with 99% confidence is $S_{\min} = 2.30$, and the lower bound with 5σ confidence is $S_{\min} = 2.23$, which comfortably violates the CHSH inequality.

-
- [1] J. S. Bell, *Physics* **1**, 195 (1964).
- [2] J. F. Clauser, M. A. Horne, A. Shimony, and R. A. Holt, *Phys. Rev. Lett.* **23**, 880 (1969).
- [3] S. J. Freedman and J. F. Clauser, *Phys. Rev. Lett.* **28**, 938 (1972).
- [4] A. Aspect, P. Grangier, and G. Roger, *Phys. Rev. Lett.* **47**, 460 (1981).
- [5] T. Norsen, *Am. J. Phys.* **79**, 1261 (2011).
- [6] The BIG Bell Test Collaboration, *Nature* **557**, 212 (2018).
- [7] N. Brunner, D. Cavalcanti, S. Pironio, V. Scarani, and S. Wehner, *Reviews of Modern Physics* **86**, 419 (2014).
- [8] V. Scarani, *Bell Nonlocality*, Oxford Graduate Texts (Oxford University Press, Oxford, New York, 2019).
- [9] I. Marinković, A. Wallucks, R. Riedinger, S. Hong, M. Aspelmeyer, and S. Gröblacher, *Phys. Rev. Lett.* **121**, 220404 (2018).
- [10] K. C. Lee, M. R. Sprague, B. J. Sussman, J. Nunn, N. K. Langford, X.-M. Jin, T. Champion, P. Michelberger, K. F. Reim, D. England, *et al.*, *Science* **334**, 1253 (2011).
- [11] A. Jorio, M. Kasparczyk, N. Clark, E. Neu, P. Maletinsky, A. Vijayaraghavan, and L. Novotny, *Phys. Status Solidi B* **252**, 2380 (2015).
- [12] M. Kasparczyk, A. Jorio, E. Neu, P. Maletinsky, and L. Novotny, *Optics Letters* **40**, 2393 (2015).
- [13] D. G. England, K. A. G. Fisher, J.-P. W. MacLean, P. J. Bustard, K. Heshami, K. J. Resch, and B. J. Sussman, *Phys. Rev. Lett.* **117**, 073603 (2016).
- [14] M. D. Anderson, S. T. Velez, K. Seibold, H. Flayac, V. Savona, N. Sangouard, and C. Galland, *Phys. Rev. Lett.* **120**, 233601 (2018).
- [15] P. J. Bustard, J. Erskine, D. G. England, J. Nunn, P. Hockett, R. Lausten, M. Spanner, and B. J. Sussman, *Opt. Lett.*, **OL 40**, 922 (2015).
- [16] M. Kasparczyk, F. S. de Aguiar Júnior, C. Rabelo, A. Saraiva, M. F. Santos, L. Novotny, and A. Jorio, *Phys. Rev. Lett.* **117**, 243603 (2016).
- [17] A. Saraiva, F. S. d. A. Júnior, R. de Melo e Souza, A. P. Pena, C. H. Monken, M. F. Santos, B. Koiller, and A. Jorio, *Phys. Rev. Lett.* **119**, 193603 (2017).
- [18] D. G. England, P. J. Bustard, J. Nunn, R. Lausten, and B. J. Sussman, *Phys. Rev. Lett.* **111**, 243601 (2013).
- [19] D. G. England, K. Fisher, J.-P. W. MacLean, P. J. Bustard, R. Lausten, K. J. Resch, and B. J. Sussman, *Phys. Rev. Lett.* **114**, 053602 (2015).
- [20] P. J. Bustard, D. G. England, K. Heshami, C. Kupchak, and B. J. Sussman, *Opt. Lett.*, **OL 41**, 5055 (2016).
- [21] K. A. G. Fisher, D. G. England, J.-P. W. MacLean, P. J. Bustard, K. J. Resch, and B. J. Sussman, *Nat. Commun.* **7**, 11200 (2016).
- [22] P. J. Bustard, D. G. England, K. Heshami, C. Kupchak, and B. J. Sussman, *Phys. Rev. A* **95**, 053816 (2017).
- [23] K. A. G. Fisher, D. G. England, J.-P. W. MacLean, P. J. Bustard, K. Heshami, K. J. Resch, and B. J. Sussman, *Phys. Rev. A* **96**, 012324 (2017).
- [24] K. C. Lee, B. J. Sussman, M. R. Sprague, P. Michelberger, K. F. Reim, J. Nunn, N. K. Langford, P. J. Bustard, D. Jaksch, and I. A. Walmsley, *Nat. Photon.* **6**, 41 (2012).
- [25] P. J. Bustard, R. Lausten, D. G. England, and B. J. Sussman, *Phys. Rev. Lett.* **111**, 083901 (2013).
- [26] P.-Y. Hou, Y.-Y. Huang, X.-X. Yuan, X.-Y. Chang, C. Zu, L. He, and L.-M. Duan, *Nature Communications* **7**, 11736 (2016).
- [27] C. Galland, N. Sangouard, N. Piro, N. Gisin, and T. J. Kippenberg, *Phys. Rev. Lett.* **112**, 143602 (2014).
- [28] R. Riedinger, S. Hong, R. A. Norte, J. A. Slater, J. Shang, A. G. Krause, V. Anant, M. Aspelmeyer, and S. Gröblacher, *Nature* **530**, 313 (2016).
- [29] S. T. Velez, K. Seibold, N. Kipfer, M. D. Anderson, V. Sudhir, and C. Galland, *Phys. Rev. X* **9**, 041007 (2019).
- [30] D. Mayers and A. Yao, in *Proceedings of the 39th Annual Symposium on Foundations of Computer Science* (IEEE Computer Society, 1998) p. 503.
- [31] D. Mayers and A. C.-C. Yao, *Quantum Information & Computation* **4**, 273 (2004).
- [32] I. Šupić and J. Bowles, *arXiv:1904.10042* (2019).
- [33] D. A. Long, in *The Raman Effect* (John Wiley & Sons, Ltd, 2002) pp. 85–152.
- [34] P. Roelli, C. Galland, N. Piro, and T. J. Kippenberg, *Nat. Nano.* **11**, 164 (2016).
- [35] I. Marcikic, H. de Riedmatten, W. Tittel, V. Scarani, H. Zbinden, and N. Gisin, *Phys. Rev. A* **66**, 062308 (2002).
- [36] J.-D. Bancal, K. Redeker, P. Sekatski, W. Rosenfeld, and N. Sangouard, *arXiv:1812.09117* (2018).
- [37] H. De Riedmatten, J. Laurat, C.-W. Chou, E. Schomberg, D. Felinto, and H. J. Kimble, *Phys. Rev. Lett.* **97**, 113603 (2006).
- [38] F. Waldermann, B. J. Sussman, J. Nunn, V. Lorenz, K. Lee, K. Surmacz, K. Lee, D. Jaksch, I. Walmsley, P. Spizziri, *et al.*, *Phys. Rev. B* **78**, 155201 (2008).
- [39] A. H. Ghadimi, S. A. Fedorov, N. J. Engelsen, M. J. Beryhi, R. Schilling, D. J. Wilson, and T. J. Kippenberg, *Science* **360**, 764 (2018).
- [40] M. Żukowski, A. Zeilinger, M. A. Horne, and A. K. Ek-

- ert, *Phys. Rev. Lett.* **71**, 4287 (1993).
- [41] J. T. Hill, A. H. Safavi-Naeini, J. Chan, and O. Painter, *Nat. Commun.* **3**, 1196 (2012).
- [42] L. Chen, J. A. Lau, D. Schwarzer, J. Meyer, V. B. Verma, and A. M. Wodtke, *Science* **363**, 158 (2018).
- [43] S. S. Kondov, C.-H. Lee, K. H. Leung, C. Liedl, I. Majewska, R. Moszynski, and T. Zelevinsky, *Nat. Phys.* **15**, 1118 (2019).
- [44] A. Maser, B. Gmeiner, T. Utikal, S. Götzinger, and V. Sandoghdar, *Nat Photon* **10**, 450 (2016).
- [45] S. Yampolsky, D. A. Fishman, S. Dey, E. Hulkko, M. Banik, E. O. Potma, and V. A. Apkarian, *Nat Photon* **8**, 650 (2014).
- [46] D. Riedel, S. Flagan, P. Meletinsky, and R. J. Warburton, *arXiv:1909.12333* (2019).
- [47] H. Flayac and V. Savona, *Phys. Rev. Lett.* **113**, 143603 (2014).
- [48] D. A. Lidar and K. Birgitta Whaley, in *Irreversible Quantum Dynamics*, edited by F. Benatti and R. Floreanini (Springer Berlin Heidelberg, Berlin, Heidelberg, 2003) pp. 83–120.
- [49] F.-G. Deng, B.-C. Ren, and X.-H. Li, *Science Bulletin* **62**, 46 (2017).
- [50] X. Chen, X. Lu, S. Dubey, Q. Yao, S. Liu, X. Wang, Q. Xiong, L. Zhang, and A. Srivastava, *Nat. Phys.* **15**, 221 (2019).
- [51] M. Aspelmeyer, T. J. Kippenberg, and F. Marquardt, *Rev. Mod. Phys.* **86**, 1391 (2014).
- [52] A. Halpin, P. J. M. Johnson, R. Tempelaar, R. S. Murphy, J. Knoester, T. L. C. Jansen, and R. J. D. Miller, *Nat. Chem.* **6**, 196 (2014).
- [53] H.-G. Duan, V. I. Prokhorenko, R. J. Cogdell, K. Ashraf, A. L. Stevens, M. Thorwart, and R. J. D. Miller, *Proc Natl Acad Sci U S A* **114**, 8493 (2017).